

**FX-300**

Série FX-300

FX-301

Zosilňovač k optickým káblom

- Funkcia učenia (Teach In)
- Vysoká citlivosť - dlhý dosah
- Rozšírené funkcie a funkčné vlastnosti, ale stále jednoduché použitie
- Super vysoká rýchlosť odozvy až 35 μ s

**POPIS PRODUKTU**

Detekcia miniatúrnych predmetov, elektronických súčiastok ako sú odpory, kondenzátory, integrované obvody pri osadzovaní dosiek plošných spojov, detekcia farebných značiek pri balení, tlačí atď ...

	<p>Štandardný model s červenou LED diódou FX-301 (P) bol vylepšený rozšírením jeho stability snímania a je vybavený šikovnými funkciami ako je funkcia voľby rozsahu vysielaného svetla.</p> <p>Tým je uľahčené použitie vláknových senzorov pri zachovaní vynikajúcich prevádzkových vlastností konvenčných modelov.</p>
	<p>Super vysoká rýchlosť odozvy až 35 μs</p> <p>Nový model FX-301 (P) -HS je digitálnym typom vláknového senzora realizujúceho supervysokú rýchlosť odozvy až 35 μs. Tak je umožnené snímání drobných objektov pohybujúcich sa vysokou rýchlosťou. Pri 65 μs u štandardného modelu FX-301 (P) (režim H-SP) tak realizuje dvojnásobnú rýchlosť oproti konvenčnému modelu.</p>
	<p>Stabilný snímání po dlhú aj krátku periódu</p> <p>Okrem štyroch chemických vysielacích prvkov, ktoré potlačajú zmeny v prvkoch vysielania svetla tak, aby bola dosiahnutá stabilná úroveň svetelného vysielania po dlhú dobu, bol tiež prispôsobený nový obvod APC (Auto Power Control). Tak bolo potlačené kolísanie v krátkych časových periódách a tým bolo umožnené stabilné snímání, ktorého možno dosiahnuť veľmi rýchlo po zapnutí napájacieho napätia a po zmenách nastavení.</p>
	<p>Rozsah snímání bol značne zvýšený</p> <p>Všetky modely využívajú zabudované dve šošovky a maximalizujú tak účinnosť vysielaného svetla, čo značne zväčšuje rozsah snímání. Rozsah snímání u vlákien s malým priemerom a veľmi malým priemerom vlákien, ktoré sa stávajú stále populárnejšie v dôsledku miniaturizácie komponentov čipov, bol zvýšený o 50% nad predchádzajúce hodnoty dosahované s inými zosilňovačmi.</p>

DIMENSIONS (Unit: mm in)

FX-301□ FX-305(P) Amplifier

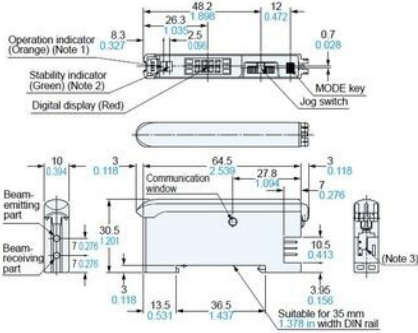

- Notes: 1) FX-305:: Output 1 operation indicator (Orange)
 2) FX-305:: Output 2 operation indicator (Orange)
 3) FX-301:: 3-pin, FX-305:: 4-pin

FX-301(HS) NPN output type IO circuit diagram

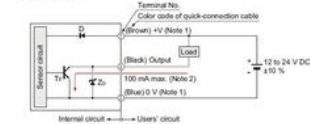

- Notes: 1) The quick-connection sub cable does not have +V (brown) and 0V (blue). The power is supplied from the connector of the main cable.
 2) 50 mA max. if five amplifiers, or more, are connected together.
 Symbols: D Reverse supply polarity protection diode
 Zp Surge absorption zener diode
 Tr NPN output transistor

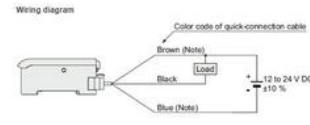

Note: The quick-connection sub cable does not have brown lead wire and blue lead wire.

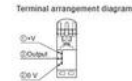

FX-301P(HS) PNP output type IO circuit diagram

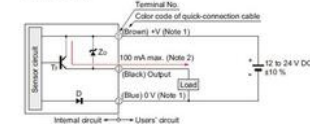

- Notes: 1) The quick-connection sub cable does not have +V (brown) and 0V (blue). The power is supplied from the connector of the main cable.
 2) 50 mA max. if five amplifiers, or more, are connected together.
 Symbols: D Reverse supply polarity protection diode
 Zp Surge absorption zener diode
 Tr PNP output transistor

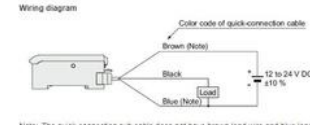

Note: The quick-connection sub cable does not have brown lead wire and blue lead wire.

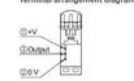

FX-305 NPN output type IO circuit diagram

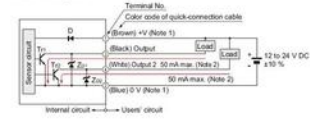

- Notes: 1) The quick-connection sub cable does not have +V (brown) and 0V (blue). The power is supplied from the connector of the main cable.
 2) 25 mA max. if five amplifiers, or more, are connected together.
 Symbols: D Reverse supply polarity protection diode
 Zp1, Zp2 Surge absorption zener diode
 Tr1, Tr2 NPN output transistor

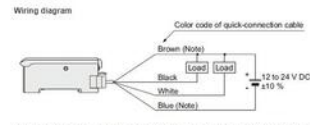

Note: The quick-connection sub cable does not have brown lead wire and blue lead wire.

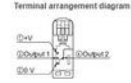

FX-305P PNP output type IO circuit diagram

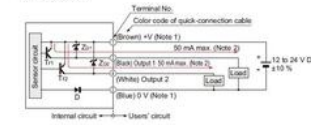

- Notes: 1) The quick-connection sub cable does not have +V (brown) and 0V (blue). The power is supplied from the connector of the main cable.
 2) 25 mA max. if five amplifiers, or more, are connected together.
 Symbols: D Reverse supply polarity protection diode
 Zp1, Zp2 Surge absorption zener diode
 Tr1, Tr2 PNP output transistor

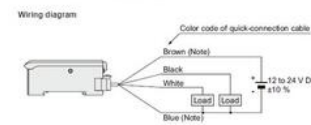

Note: The quick-connection sub cable does not have brown lead wire and blue lead wire.

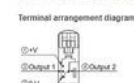

DIMENSIONS (Unit: mm in)

FX-301□ FX-305(P) Amplifier

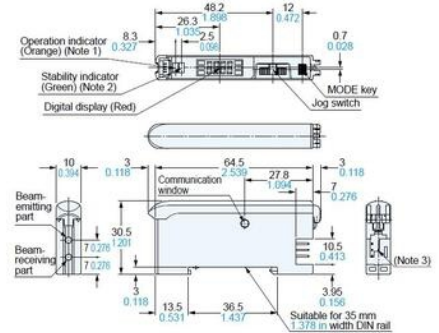

- Notes: 1) FX-305:: Output 1 operation indicator (Orange)
 2) FX-305:: Output 2 operation indicator (Orange)
 3) FX-301:: 3-pin, FX-305:: 4-pin

FX-301(HS) NPN output type IO circuit diagram

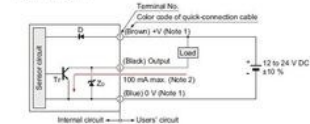

- Notes: 1) The quick-connection sub cable does not have +V (brown) and 0V (blue). The power is supplied from the connector of the main cable.
 2) 50 mA max. if five amplifiers, or more, are connected together.
 Symbols: D Reverse supply polarity protection diode
 Zp Surge absorption zener diode
 Tr NPN output transistor

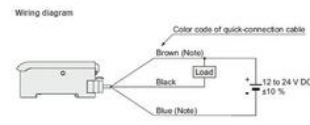

Note: The quick-connection sub cable does not have brown lead wire and blue lead wire.

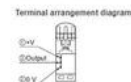

FX-301P(HS) PNP output type IO circuit diagram

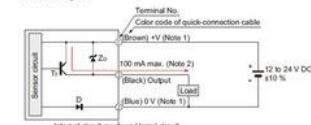

- Notes: 1) The quick-connection sub cable does not have +V (brown) and 0V (blue). The power is supplied from the connector of the main cable.
 2) 50 mA max. if five amplifiers, or more, are connected together.
 Symbols: D Reverse supply polarity protection diode
 Zp Surge absorption zener diode
 Tr PNP output transistor

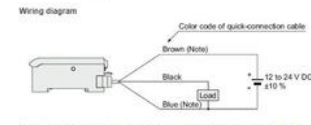

Note: The quick-connection sub cable does not have brown lead wire and blue lead wire.

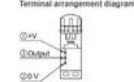

FX-305 NPN output type IO circuit diagram

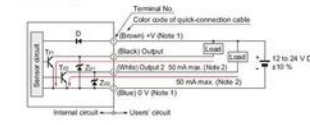

- Notes: 1) The quick-connection sub cable does not have +V (brown) and 0V (blue). The power is supplied from the connector of the main cable.
 2) 25 mA max. if five amplifiers, or more, are connected together.
 Symbols: D Reverse supply polarity protection diode
 Zp1, Zp2 Surge absorption zener diode
 Tr1, Tr2 NPN output transistor

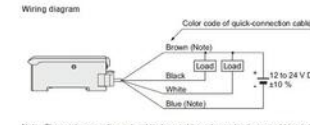

Note: The quick-connection sub cable does not have brown lead wire and blue lead wire.

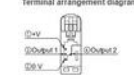

FX-305P

PNP output type
I/O circuit diagram

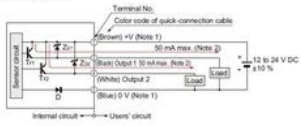

- Notes:
- 1) The quick-connection sub cable does not have +V (brown) and 0 V (blue). The power is supplied from the connector of the main cable.
 - 2) 25 mA max. if five amplifiers, or more, are connected together.
- Symbols: — D: Reverse supply polarity protection diode
 Z₀₁, Z₀₂: Surge absorption zener diode
 T₁, T₂: PNP output transistor

Wiring diagram

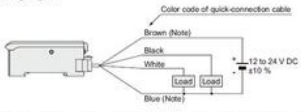

Note: The quick-connection sub cable does not have brown lead wire and blue lead wire.

Terminal arrangement diagram

