



Dopyt

ODSTREDIVÉ ČERPADLÁ

Série 50860

50860-0012

Odstredivé čerpadlá



- Prietok až 80 l/min
- Tlak až 1,3 Bar

POPIS PRODUKTU

ŠPECIFIKÁCIA

Elastomer	Nitril
Hmotnosť	10,5 kg
Material impeller	Odolný voči kyselinám
Material of axle seal	Uhlík / keramika
Material of shaft	Odolný voči kyselinám
Materiál tela	Odolný voči kyselinám
Materiál tesnenia	Nitril
Max. dovolený tlak	1,8 bar
Prietok max.	80 l/min
Procesné pripojenie	3/4 NPT
Prúd max.	21 A
Teplota média do	95 °C
Teplota média od	4 °C
Viscosity Max	20 cP

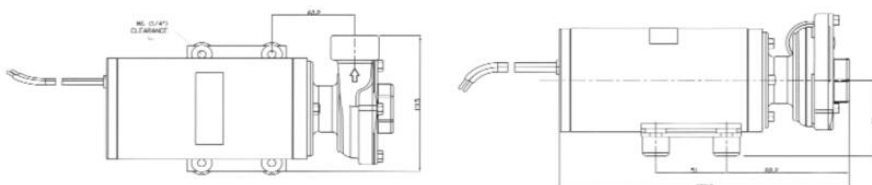

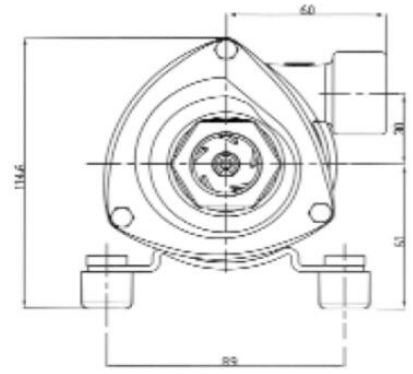

50870-Series Cyclone Performance
 Typical performance based on pumps running at 12.8V and 25.6V DC

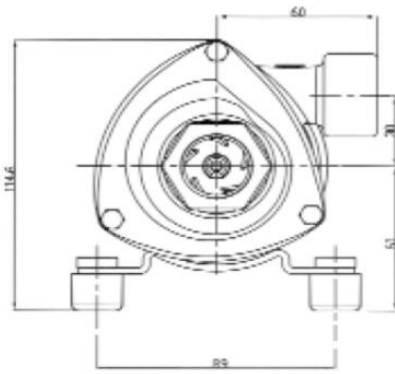
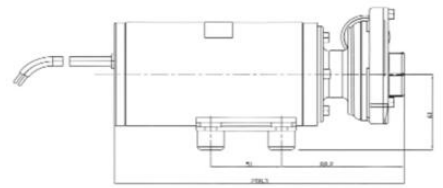
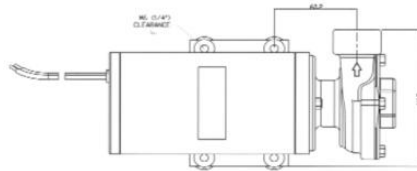
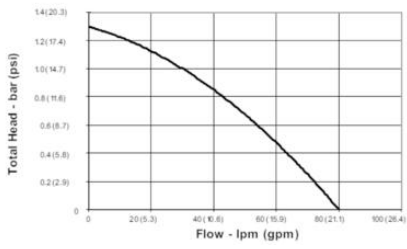

50870-Series Cyclone Performance
 Typical performance based on pumps running at 12.8V and 25.6V DC

